

24" OVER-THE-RANGE MICROWAVE OVEN







DISTINTO 400 SERIES



MODEL CODE

F4OTR24S2



-  Sensor Cooking
-  Power Selection
-  Touch Controls
-  Presets
-  950 Watts
-  Auto Defrost
-  Child Safety Lock

FEATURES

- 10 Power Levels
- White LED Display & Digital Clock
- LED lighting
- Child-Safe Lock-Out Feature
- Display ON/OFF (controlled via Clock key)
- Removable Glass Turntable for complete, even cooking

VENTILATION

- Ventilation Fan Speed HIGH/LOW/OFF (Max. 300 CFM)
- 1 Charcoal Filter

FUNCTIONS

- 10 Sensor Cooking Functions – (Baked Potato, Sweet Potato, Fish/Seafood, Brown Rice, White Rice, Vegetables, Ground Meat, Frozen Entrée)
- 5 Warming Functions – (Syrup, Dessert Toppings, Beverage Reheat, Hot Water, Hot Cereal)
- 4 Melt / Soften Menu (Butter, Chocolate / Ice cream, Cream Cheese)
- 6 Defrost Functions – (Ground Meat, Steaks/Chops, Boneless Poultry, Bone-in Poultry, Roast, Casserole and Soup)

24" OVER-THE-RANGE MICROWAVE OVEN



MODEL CODE

DISTINTO 400 SERIES

F4OTR24S2

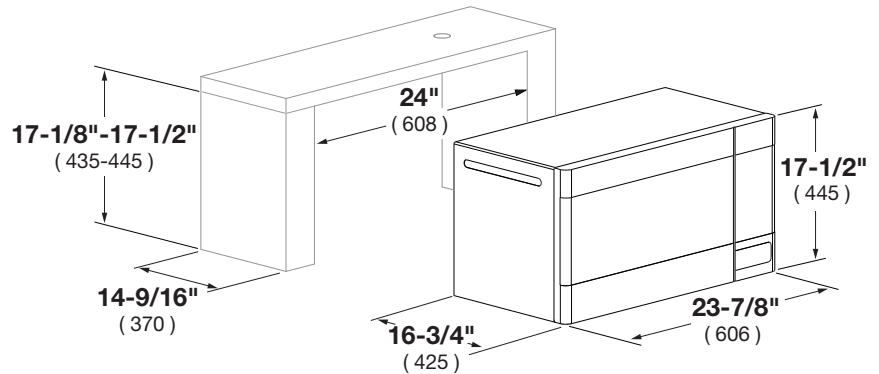

MODEL CODE	24" OVER-THE-RANGE MICROWAVE OVEN F4OTR24S2
GENERAL DETAILS	
Finish	Black Glass / Stainless Steel
Microwave Type	Turn table / Recessed Cavity
Control Type	Electronic Touch Control
Display & Digital Clock	White LED / 7-segment
CAPACITY	
Volume, cu. ft. (L)	1.4 (39.6)
Useable Width, in. (mm)	15-5/16 (389)
Useable Height, in. (mm)	10-13/16 (275)
Useable Depth, in. (mm)	15-1/4 (387)
DIMENSIONS / WEIGHT	
Turn table Diameter, in. (mm)	12-13/16 (325)
Product Width, in. (mm)	23-7/8 (606)
Product Height, in. (mm)	17-1/2 (445)
Product Depth, in. (mm)	16-3/4 (425)
Cutout Width, in. (mm)	24 (608)
Cutout Height (min.-max.), in. (mm)	17-1/8 (435) - 17-1/2 (445)
Cutout Depth (max.), in. (mm)	14-9/16 (370)
Net Weight, lbs. (kg)	51.6 (23.4)
POWER / RATINGS (120 V - 60 Hz)	
Energy Output	1000 W
Supply Voltage	120 V - 60 Hz
Rated Current	20 A
Fan Capacity	300 CFM
TECHNICAL DETAILS	
Power Cable Length, in. (mm)	39-3/4 (1010)
Electrical Circuit	120 V - 60 Hz - 20 A
INSTRUCTIONS FOR USE	
Use & Care Manual / Installation Manual	English / French
WARRANTY	
Limited Warranty	Parts and Labor (1-year)